



YM2X18-050EG1MRJA8

Industrial Ethernet cables and fieldbus cables

SICK
Sensor Intelligence.



Ordering information

Type	Part no.
YM2X18-050EG1MRJA8	2106259

Other models and accessories → www.sick.com/Industrial_Ethernet_cables_and_fieldbus_cables



Detailed technical data

Technical specifications

Connection type head A	Male connector, M12, 8-pin, straight, X-coded				
Connection type head B	Male connector, RJ45, 8-pin, straight				
Locking plug connector	Screw-on connection (M12), snap-in locking (RJ45)				
Connector material	TPU				
Connector color	Black				
Locking nut material	Zinc die-cast, nickel-plated				
Tightening torque	0.6 Nm				
Width across flats	13				
Cable	5 m, 8-wire, PUR, halogen-free				
Jacket material	PUR, halogen-free				
Jacket color	Green				
Cable diameter	6.4 mm				
Conductor cross section	0,14 mm ²				
Shielding	Shielded				
Bending radius	<table border="0"> <tr> <td style="padding-right: 20px;">Flexible use</td> <td>> 10 x cable diameter</td> </tr> <tr> <td>Stationary position</td> <td>> 8 x cable diameter</td> </tr> </table>	Flexible use	> 10 x cable diameter	Stationary position	> 8 x cable diameter
Flexible use	> 10 x cable diameter				
Stationary position	> 8 x cable diameter				
Nominal voltage, cable	125 V AC				
Test voltage, cable	1,000 V AC				
Reference voltage	<table border="0"> <tr> <td>48 V AC</td> </tr> <tr> <td>60 V DC</td> </tr> </table>	48 V AC	60 V DC		
48 V AC					
60 V DC					
Rated impulse voltage	1 kV				
Current loading	0.5 A				
Signal type	Ethernet, Gigabit Ethernet				
Transmission characteristics	CAT6A				
Data transmission rate	≤ 10 Gbit/s				
Application	Zones with oils and lubricants				
Authorizations	CE UL				

UL File No.	E513908
Enclosure rating	IP65/ IP67 (M12), IP20 (RJ45)
Operating temperature	
Stationary position	-40 °C ... +80 °C
Head	-25 °C ... +85 °C
Contamination rating	3
Insulation resistance	> 100 mΩ
Overvoltage category	III
Specific insulation resistance	< 30 mΩ
Thermal resistance, piping	Flame retardant acc. to UL 1581 Section 1090, Section 1100 (FT2), Section 1080 (VW-1) / IEC 60332-1-2

Classifications

ECLASS 5.0	19030312
ECLASS 5.1.4	19030312
ECLASS 6.0	27060304
ECLASS 6.2	27060304
ECLASS 7.0	27060304
ECLASS 8.0	27060304
ECLASS 8.1	27060304
ECLASS 9.0	27060304
ECLASS 10.0	27060304
ECLASS 11.0	27060304
ECLASS 12.0	27060304
ETIM 5.0	EC000830
ETIM 6.0	EC000830
ETIM 7.0	EC003249
ETIM 8.0	EC003249
UNSPSC 16.0901	26121604

Dimensional drawing (Dimensions in mm (inch))

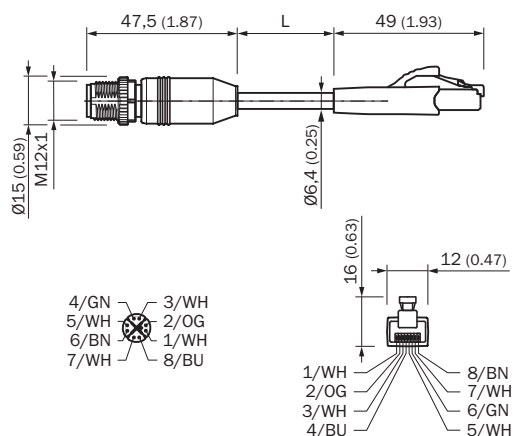

SICK AT A GLANCE

SICK is one of the leading manufacturers of intelligent sensors and sensor solutions for industrial applications. A unique range of products and services creates the perfect basis for controlling processes securely and efficiently, protecting individuals from accidents and preventing damage to the environment.

We have extensive experience in a wide range of industries and understand their processes and requirements. With intelligent sensors, we can deliver exactly what our customers need. In application centers in Europe, Asia and North America, system solutions are tested and optimized in accordance with customer specifications. All this makes us a reliable supplier and development partner.

Comprehensive services complete our offering: SICK LifeTime Services provide support throughout the machine life cycle and ensure safety and productivity.

For us, that is “Sensor Intelligence.”

WORLDWIDE PRESENCE:

Contacts and other locations –www.sick.com